

COD. DIS. 71.9514.00

* Lubrificare con grasso al silicone.
 * Lubricate with silicon grease.
 * Graisser avec de la graisse su silicone.

* Schmierien mit Silikonfett.

* Lubrique con grasa de silicona.

* Lubrifique com graxa de silicone.

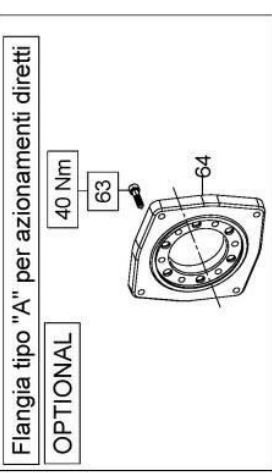

** Fissare con Loctite 243 col. BLU
 ** Affix with Loctite 243 col. BLUE
 ** Fixer avec de la Loctite 243 couleur BLUE
 ** Mit Loctite 243 BLAU befestigen
 ** Fijar con Loctite 243 col. AZUL
 ** Fixar com Loctite 243 cor. BLUE

WK

SERIE 71

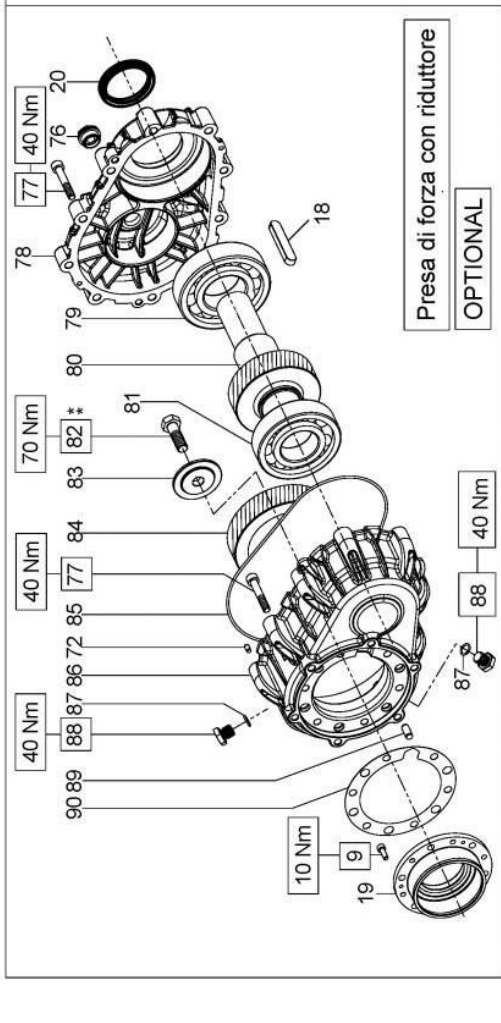
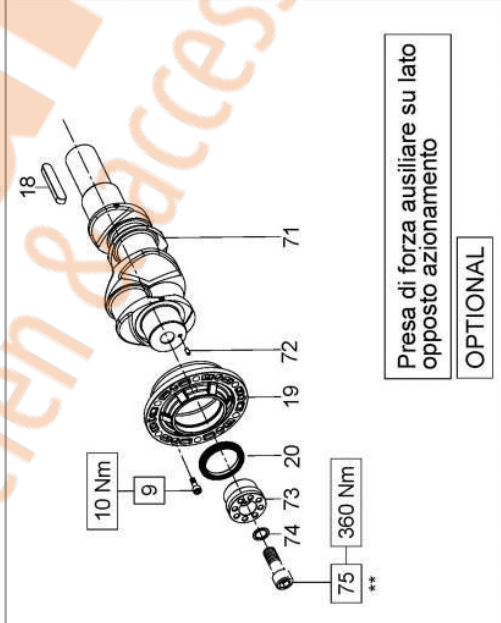
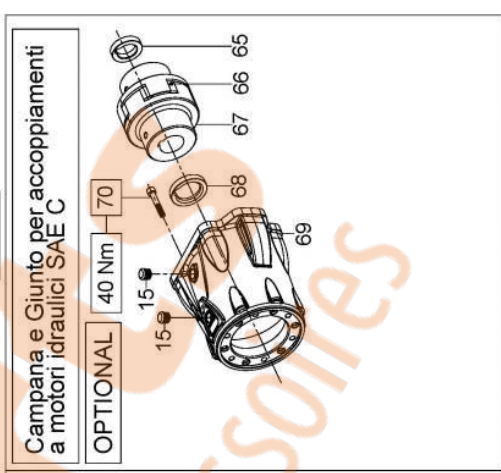
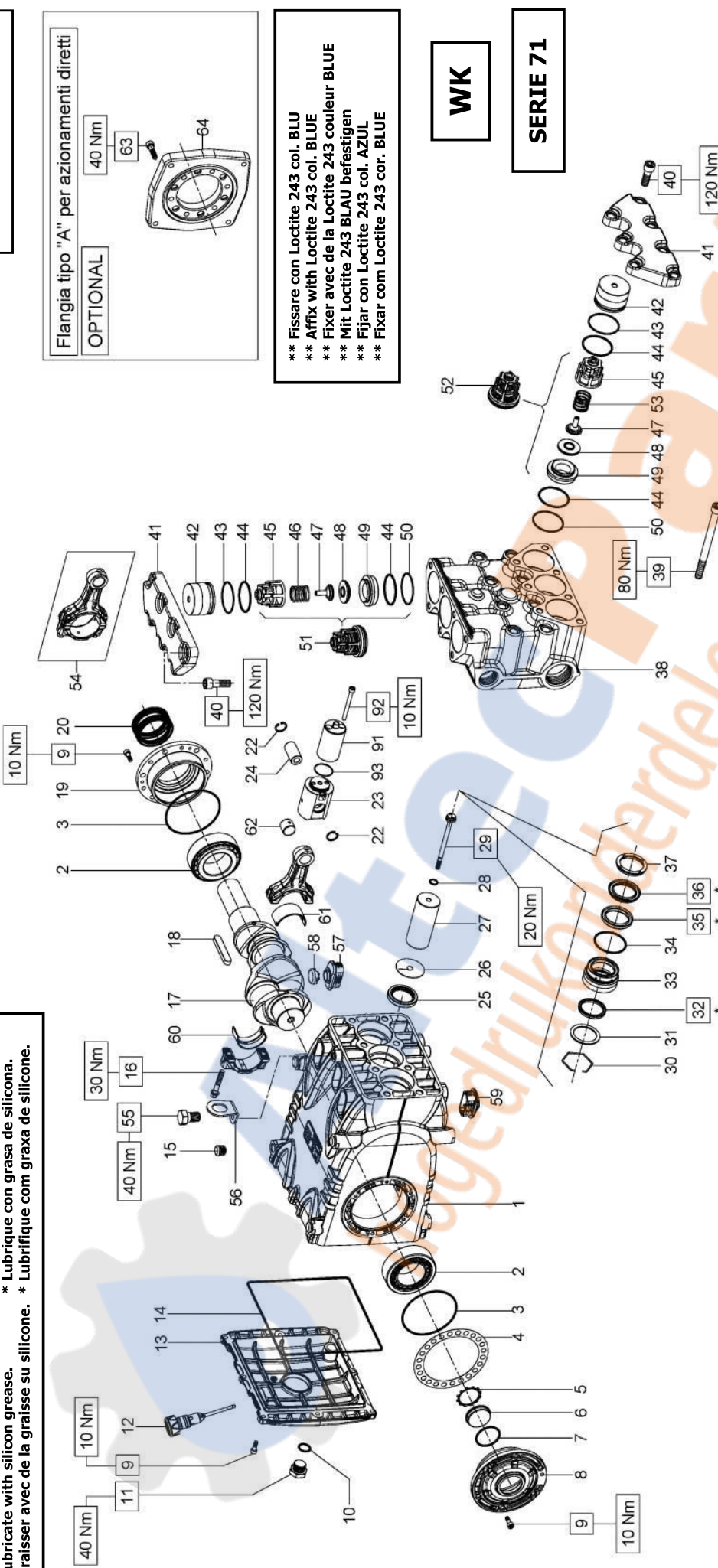

Presa di forza ausiliare su lato opposto azionamento
 OPTIONAL

Presa di forza con riduttore
 OPTIONAL

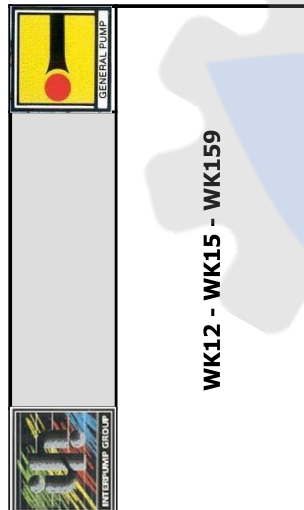

WK12 - WK15 - WK159

KIT RICAMBI - SPARE KITS

KIT NR.	KIT 2012	KIT 2013	KIT 2135 2154 - 2155	PISTONE - PISTON D. 30		PISTONE - PISTON D. 32		PISTONE - PISTON D. 36	
				KIT 2016	KIT 2017	KIT 2066	KIT 2222	KIT 2018	KIT 2019
Posizioni includi Positions included	44 - 45 47 - 48 49 - 50 53 (52)	44 - 45 46 - 47 48 - 49 50 (51)	60 - 61	32 - 34 35 - 36	3 - 5 - 7 - 10 14 - 20 - 25 28 - 32 - 34 35 - 36 - 37 43 - 44 - 50	32 - 34 35 - 36	3 - 5 - 7 - 10 14 - 20 - 25 28 - 32 - 34 35 - 36 - 37 43 - 44 - 50	32 - 34 35 - 36	3 - 5 - 7 - 10 14 - 20 - 25 28 - 32 - 34 35 - 36 - 37 43 - 44 - 50
Nr. Pcs.	3	3	3	3	1	3	1	3	1

PISTON D. 30		PISTON D. 32		PISTON D. 36	
WK159	WK12	WK15			
POS	COD.	DESCRIZIONE - DESCRIPTION - KIT	NR		NR
1	71.0100.22	Carter pompa	1		
2	91.8590.00	Cuscinetto a rulli	2		
3	90.3918.00	OR D. 94.92x2.62 NBR SH. 70 3375 2017-2222-2019	2		
4	71.2200.81 71.2203.81	Spessore 0.1 mm. Spessore 0.25 mm.	-		
5	90.0756.00	Anello d'arresto ZJ45	1	2017-2222-2019	
6	70.2118.01	Spia livello olio	1		
7	90.3877.00	OR D. 39.34x2.62 NBR SH. 70 3156 2017-2222-2019	1		
8	71.1501.22	Coperchio cuscinetto lato spia	1		
9	99.1867.00	Vite M6x18 UNI 5931	20		
10	90.3841.00	OR D. 17.13x2.62 NBR SH. 70 3068 2017-2222-2019	4		
11	98.2187.00	Tappo G 1/2"x10 TE27 Zinc.	1		
12	98.2120.00	Tappo con asta D. 21.5x91	1		
13	71.1600.22	Coperchio posteriore carter	1		
14	90.4000.00	OR D. 215.00x3.00 NBR SH. 70 2017-2222-2019	1		
15	98.2060.00	Tappo per foro D. 15	4		
16	99.3138.00	Vite serraggio biella	6		
17	71.0200.35	Albero ecc. C.50	1		

POS	COD.	DESCRIZIONE - DESCRIPTION - KIT	NR
18	91.5000.00	Linguetta 9x8x70 UNI 6604	1
19	71.1500.22	Coperchio cuscinetto lato PTO	1
20	90.1700.00	An. rad. D. 50.0x65.0x8.0	1
22	90.0606.00	Anello d'arresto J20	6
23	71.0507.15	Guida pistone	3
24	97.7430.00	Spinotto D. 20x38	3
25	90.1678.00	Anello rad. D. 38.0x52.0x7.0/8.5 2017-2222-2019	3
26	96.7140.00	Rosetta D. 10.0x50.0x1.0	3
27	71.0403.09 71.0404.09 72.0400.09	Pistone D. 30x95 Pistone D. 36x95 Pistone D. 32x95	3
28	90.3671.00	OR D. 11.00x2.00 NBR SH. 90 2017-2222-2019	3
29	71.2195.66	Vite fissaggio pistone	3
30	90.0797.00	Anello di d'arresto D. 52	3
31	71.2177.70 72.2105.70 71.2180.70	Anello per tenuta D. 30 Anello per tenuta D. 32 Anello per tenuta D. 36	3
32	90.2760.00 90.2780.00 90.2800.00	An. ten. alt. D. 30x38x5.5 LP An. ten. alt. D. 32x40x5.5 LP An. ten. alt. D. 36x40x6 LP	3
33	71.2153.70 72.2104.70 71.2154.70	Supporto guarnizioni D. 30 Supporto guarnizioni D. 32 Supporto guarnizioni D. 36	3
34	90.3891.00	OR D. 52.07x2.62 NBR SH. 70 3206 2016-2017-2066-2222-2018-2019	3

POS	COD.	DESCRIZIONE - DESCRIPTION - KIT	NR
35	90.2774.00 90.2784.00 90.2818.00	An. RESTOP D. 30x45x8/4.5 An. RESTOP D. 32x44x5.5/3 An. RESTOP D. 36x45x6/3	3
36	90.2770.00 90.2788.00 90.2820.00	An. ten. alt. D. 30x45x7.5/4.5 HP An. ten. alt. D. 32x44x6/3.5 HP An. ten. alt. D. 36x48x6/3.5 HP	3
37	70.1004.51 72.1000.51 71.1002.51	Anello di testa D. 30 Anello di testa D. 32 Anello di testa D. 36	3
38	71.1290.15 71.1291.15 71.1292.15 71.1293.15 71.1294.15 71.1295.15	Testata per pistone D. 30 Testata per pistone D. 30 - NPT Testata per pistone D. 32 Testata per pistone D. 32 - NPT Testata per pistone D. 36 Testata per pistone D. 36 - NPT	1
39	99.4480.00	Vite M12x150 UNI 5931	8
40	99.4295.00	Vite M12x35 UNI 5931	14
41	71.2274.15	Coperchio valvole	2
42	71.2111.70	Tappo valvole aspirazione / mandata	6
43	90.5250.00	Anello antiest. D. 50.9x55.0x1.5 2017-2222-2019	6
44	90.3889.00	OR D. 48.89x2.62 NBR SH. 70 3193 2012-2013-2017-2222-2019	12
45	36.2045.05	Guida valvola	2012-2013
46	94.7550.00	Molla Dm. 25.2x26.0	2013
47	36.2086.51	Guida valvola interna	2012-2013
48	36.2085.02	Valvola sferica	2012-2013

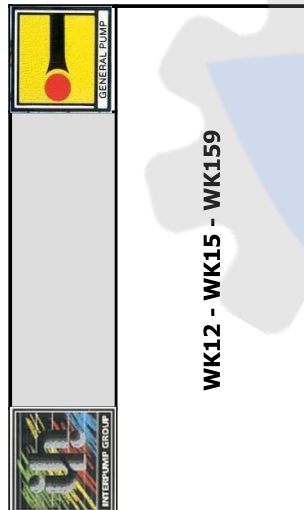

KIT RICAMBI – SPARE KITS

KIT NR.	KIT 2012			KIT 2013			KIT 2135 2154 - 2155			PISTONE – PISTON D. 30			PISTONE – PISTON D. 32			PISTONE – PISTON D. 36		
	KIT 2012	KIT 2013	KIT 2135 2154 - 2155	KIT 2016	KIT 2017	KIT 2066	KIT 2222	KIT 2018	KIT 2019									
Posizioni incluse Positions included	44 - 45 47 - 48 49 - 50 53 (52)	44 - 45 46 - 47 48 - 49 50 (51)	60 - 61	32 - 34 35 - 36	3 - 5 - 7 - 10 14 - 20 - 25 28 - 32 - 34 35 - 36 - 37 43 - 44 - 50	32 - 34 35 - 36	3 - 5 - 7 - 10 14 - 20 - 25 28 - 32 - 34 35 - 36 - 37 43 - 44 - 50	32 - 34 35 - 36	3 - 5 - 7 - 10 14 - 20 - 25 28 - 32 - 34 35 - 36 - 37 43 - 44 - 50									
Nr. Pcs.	3	3	3	3	1	3	1	3	1									

PISTON D. 30	PISTON D. 32	PISTON D. 36
WK159	WK12	WK15

POS	COD.	DESCRIZIONE – DESCRIPTION - KIT	NR
49	36.2041.56	Sede valvola	2012-2013
50	90.5240.00	Anello antiest. D. 49.5x54.0x4.5	2012-2013-2017-2222-2019
51	36.7137.01	Gr. valvola di mandata	2013
52	36.7136.01	Gr. valvola d'aspirazione	2012
53	94.7540.00	Molla Dm. 24.7x27.0	2012
54	71.0307.01	Biella completa	3
55	99.4266.00	Vite M12x25 UNI 5739	1
56	71.2230.74	Staffa di sollevamento	1
57	71.2258.51	Tappo carter	3
58	71.2259.51	Cappuccio tappo carter	3
59	71.2258.51	Tappo carter	3
60	90.9243.00 90.9244.00 90.9245.00	Semibocc. testa biella - Inf. Semibocc. testa biella +0.25 - Inf. Semibocc. testa biella +0.50 - Inf.	2135 2154 2155
61	90.9240.00 90.9241.00 90.9242.00	Semibocc. testa biella - Sup. Semibocc. testa biella +0.25 - Sup. Semibocc. testa biella +0.50 - Sup.	2135 2154 2155
62	90.9110.00	Boccola piede biella	3
91	71.0508.66	Stelo guida pistone	3
92	99.1994.00	Vite M6x65 UNI 5931	6
93	90.3528.00	OR D. 30.00x1.5 NBR 70 SH.	3

AZIONAMENTI SPECIALI – SPECIAL DRIVES			
AZIONAMENTO DIRETTO CON FLANGIA TIPO A DIRECT DRIVE WITH FLANGE TYPE A			
POS	COD.	DESCRIZIONE – DESCRIPTION - KIT	NR
63	99.3098.00	Vite M8x35 UNI 5931	6
64	10.0677.20	Flangia motore idraulico tipo A	1
AZIONAMENTO IDRAULICO CON CAMPANA E GIUNTO SAE-C HYDRAULIC DRIVE WITH FLANGE AND FLEXIBLE COUPLING SAE-C			
15	98.2060.00	Tappo per foro D. 15	2
65	10.0745.70	Distanziale D. 31.75 H.10.5	1
66	10.0749.47	Elemento elastico	1
67	10.7428.01	Giunto elastico D. 40x31.75	1
68	10.0746.70	Distanziale D. 40 H.10	1
69	10.0750.20	Flangia motore idraulico SAE-C	1
70	99.3146.00	Vite M8x50 UNI 5931	6
AZIONAMENTO CON PRESA DI FORZA AUSILIARE DRIVE WITH AUXILIARY PTO			
9	99.1867.00	Vite M6x18 UNI 5931	6
18	91.5000.00	Linguetta 9x8x70 UNI 6604	1
19	71.1500.22	Coperchio cuscinetto lato PTO	1
20	90.1700.00	Anello rad. D. 50x65x8	1
71	70.0207.35	Albero ecc. doppio PTO	1
72	97.6152.00	Spina D. 5x10	1
73	71.2265.54	Dispositivo doppio PTO	1
74	96.7378.00	Rosetta D. 17.0x24.0x1.0	1
75	99.5142.00	Vite M16x45 UNI 5931	1

RIDUTTORE - GEARBOX			
POS	COD.	DESCRIZIONE – DESCRIPTION - KIT	NR
9	99.1867.00	Vite M6x18 UNI 5931	6
18	91.5000.00	Linguetta 9x8x70 UNI 6604	1
19	71.1500.22	Coperchio cuscinetto lato PTO	1
20	90.1700.00	Anello rad. D. 50.0x65.0x8.0	1
72	97.6152.00	Spina D. 5x10	1
76	97.5940.00	Spia livello olio G 1/2"	1
77	99.3146.00	Vite M8x50 UNI 5931	16
78	72.2109.20	Coperchio scatola riduttore	1
79	91.8593.00	Cuscinetto a sfere	1
80	10.0708.35 10.0709.35 10.0710.35	Pignone Z27 R.1.250 elicoidale Pignone Z25 R.1.500 elicoidale Pignone Z22 R.1.830 elicoidale	1
81	91.8577.00	Cuscinetto a sfere	1
82	99.4307.00	Vite M12x40 UNI 5739	1
83	72.2110.55	Rondella fissaggio corona	1
84	10.0711.35 10.0712.35 10.0713.35	Corona Z34 R.1.250 elicoidale Corona Z37 R.1.500 elicoidale Corona Z40 R.1.830 elicoidale	1
85	90.3948.00	OR D. 209.22x2.62 NBR SH. 70	1
86	72.2108.20	Scatola riduttore	1
87	90.3585.00	OR D. 10.82x1.78 NBR SH. 70 2043	2
88	98.20.47.00	Tappo G 1/4"x13	2
89	97.6185.00	Spina D. 8x18	1
90	72.2107.84	Guarnizione scatola riduttore	1